

SPECIFICATION FOR APPROVAL

(ANALOG RGB AND VIDEO INTERFACE CONTROLLER FOR TFT-LCD
INTERFACE)

MODEL : DCMR-40 /DCMR-45

APPROVE	REFERENCE

(PLEASE RETURN ONE OF THESE TO US IMMEDIATELY WITH YOUR SIGNATURE FOR APPROVAL)

1.	Revision History	4
2.	Product Overview	5
3.	Features	5
4.	System Configuration	6
5.	Electrical Specifications	7
5.1.	Video input timing for standard resolution	7
	Wide format resolutions	8
5.2.	Electrical Characteristics	9
6.	Operational Setup	10
7.	OSD (On-Screen-Display)	11
7.1.	Main Menu	11
7.2.	Sub-Memu : Color	12
7.3.	Sub-Memu : Image Setting	13
7.4.	Sub-Memu : Position	14
7.5.	Sub-Memu : OSD Menu	15
7.6.	Sub-Menu : Language	16
7.7.	Sub-Menu : Misc	17
8.	Input Connectors	18
8.1.	Power Input connector	18
8.2.	DVI Input connector, single link	19
8.3.	Analog RGB Input connector	20

8.4.	OSD, LED Interface Connector (J500)	21
9.	Output Connectors for LCD Interface.....	22
9.1.	LVDS Interface (J502).....	22
9.2.	TTL - Interface (J503)	23
9.3.	Backlight Power Connector (J501)	24
10.	Mechanical Dimension	25
11.	Reliability.....	26
12.	Absolute maximum ratings	26
13.	Mounting rules	26
14.	Operating Precautions.....	26
15.	Packing / Labels.....	27
16.	General Cautions	28

1. Revision History

Version	Date	Section	Description
1.0	1 nd Dec. 2007	All	DCMR-40E Specification
1.1	18 th June 2009	All	DCMR-40E Language update
1.2	16 th June 2010	5.1	DCMR-40E Mode update
1.21	2 nd August 2011	5.1	DCMR-40E Mode update, DCMR-45

2. Product Overview

This board accepts standard analog RGB and SYNC(CRT like) signals from any VGA to SXGA/WXGA+ video controller and standard single DVI(Digital Video Interface) signals. And also generates all the necessary control signals and the panel data to drive TFT-LCDs. This board supports to SXGA/WXGA+ resolutions at vertical refresh rate up to 75Hz. In case of DCMR-45 the upper resolution limit is 1920x1200 for 60Hz frame frequency

Lower resolution modes can be expanded to full-screen or centered through the On-Screen Menu user interface. The user interface includes Phase, Brightness, Contrast, Horizontal and Vertical Position adjustment, etc. via on-screen programming.

3. Features

- Support up to SXGA / WXGA+.(DCMR-45: up to 1920x1200, 60 Hz)
- Input format detection
- Compatibility with standard VESA Mode and support user-defined mode.
- Smart engine for Phase/Image Position/Color calibration.
- Sharpness/Smooth filter enhancement.
- Zoom scaling up and down and No external memory required.
- Fully programmable zoom ratios.
- Independent horizontal/vertical scaling.
- Advanced zoom algorithm provides high image quality.
- Require only one crystal to generate all timing.
- Support Sync On Green and various kinds of composite sync modes.
- Integrated 8-bit triple channel 165MHz ADC/PLL, (DCMR-45: up to 210 MHz)
- Dynamic contrast control / Independent color control.
- Multi-output interface (LVDS/TTL) on single PCB.
- User friendly On Screen Display Menu to control image
 - Auto-Adjust
 - Color Adjust (Contrast, Brightness, etc.)
 - Image Setting (Clock, Phase, etc.)
 - Image Position
 - OSD Setting
 - Input Source Select
 - Reset
- Power management support (DPMS - VESA compliant)
- Embedded dual DDC with DDC1/2B/CI

4. System Configuration

● Figure 1. System Block Diagram

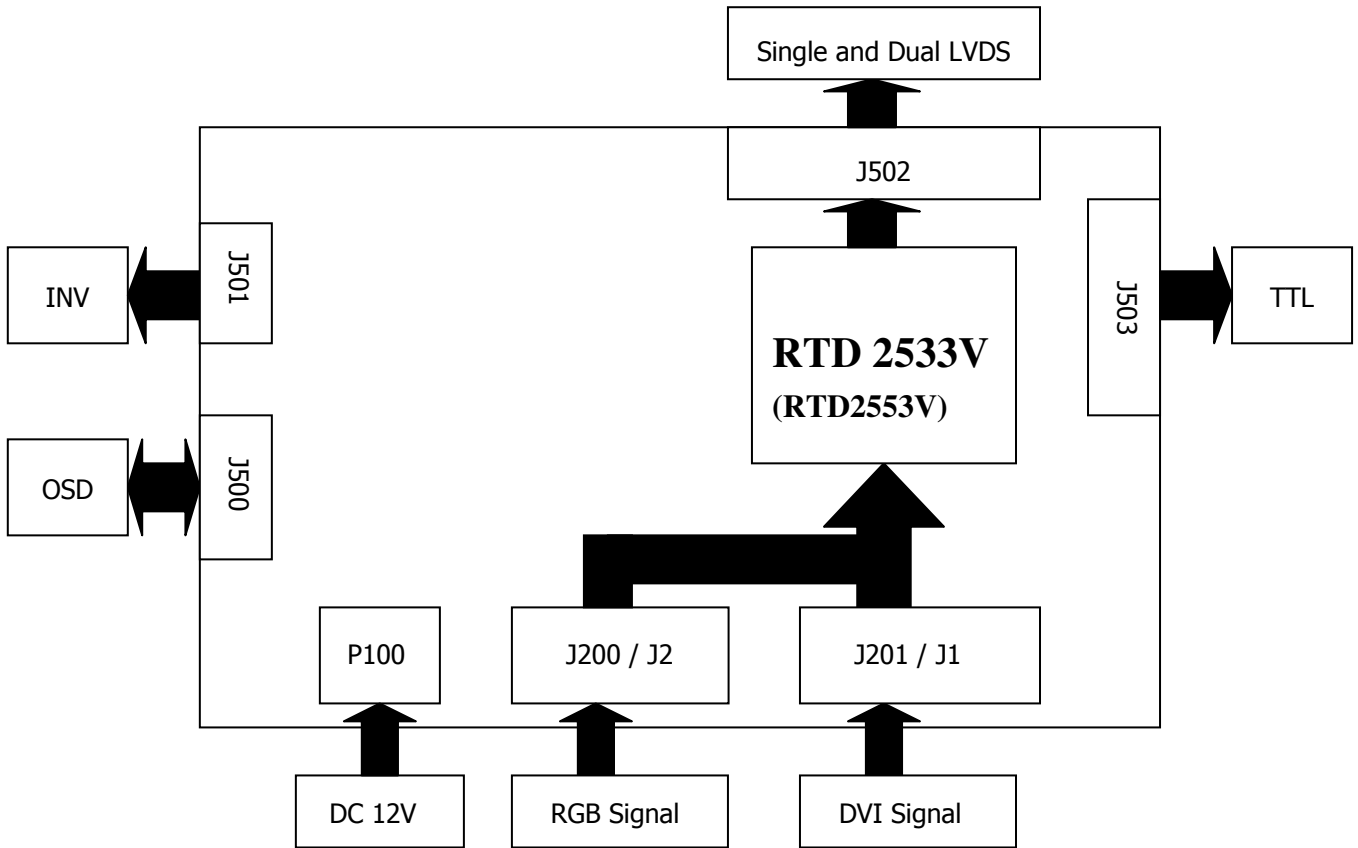

5. Electrical Specifications

5.1. Video input timing for standard resolution

Input	Standard	Resolution	Refresh Rate[Hz]	fHSYNC [KHz]	Pixel Rate [Mhz]
RGB	VGA	640x480	60	31,5	25,2
			70	35	28,6
			72	37,9	31,5
			75	37,5	31,5
	SVGA	800x600	60	37,9	40
			70	43,8	45,5
			72	48,1	50
			75	46,9	49,5
	XGA	1024x768	60	48,4	65
			70	59,5	75
			72	57,7	78,4
			75	60	78,8
	SXGA	1280x1024	60	64	108
			70	74,6	128,9
			72	76,8	132,8
			75	80	135
	UXGA	1600x1200	60	74,5	162
DVI	VGA	640x480	60	31,5	25,2
			70	35	28,6
			72	37,9	31,5
			75	37,5	31,5
	SVGA	800x600	60	37,9	40
			70	43,8	45,5
			72	48,1	50
			75	46,9	49,5
	XGA	1024x768	60	48,4	65
			70	59,5	75
			72	57,7	78,4
			75	60	78,8
	SXGA	1280x1024	60	64	108
			70	74,6	128,9
			72	76,8	132,8
			75	80	135
	UXGA	1600x1200	60	74,5	162

Wide format resolutions

Input	Standard	Resolution	Refresh Rate[Hz]	fHSYNC [KHz]	Pixel Rate [Mhz]
RGB	WXGA	1280x800	59.5	49.6	73
		1360x768	60	47.7	85.7
	WXGA+	1440x900	60	55.9	106.3
	WSXGA	1680x1050	60	65.2	146.3
	<i>Full HD</i>	<i>1920x1080</i>	<i>60</i>	<i>67.4</i>	<i>209.7</i>
DVI	WXGA	1280x800	60	49.6	73
		1360x768	60	47.7	85.7
	WXGA+	1440x900	60	55.9	106.3
	WSXGA	1680x1050	60	65.2	146.3
	<i>Full HD</i>	<i>1920x1080</i>	<i>60</i>	<i>67.4</i>	<i>209.7</i>

- Sync. : H/V Separate, Sync On Green, Interlace
- Video - RGB Analog (75 Ohm, 0.7Vp-p)
- Up to 165Mhz (*210 MHz*) standard single DVI resolution.
1920x1200 with reduced blanking at DVI input
- Timings for *DCMR-45* only in brackets or *kursiv*

5.2. Electrical Characteristics

Item	Symbol	Condition	MIN.	TYP.	MAX.	Unit
Supply Voltage		-----	7	12.0	25	Vdc
Absolute Max. Rating		-----	7	12.0	25	Vdc
Current Consumption ¹		Board Only	0.4	0.5	0.55	A
		With HT15X15- D01				A
In rush current				~		
Fuse						A
JMP100	3.3V	12 V Module PW		12		V
	5 V	5 V Module PW		5		V
	12 V	3.3 V Module PW		3.3		V
Ext. power out J6	5 V	5 V Module PW		5		V
	12 V	12 V Module PW		12		V

¹ Test was performed with the BOE Hydix HT15X15-D01 and inverters which are made by Frontek Inc

6. Operational Setup

The OSD provides certain functions to have clear image and others.

There are 5 buttons to control the OSD, PCB board and 1 LED for show status of board.

OSD Board

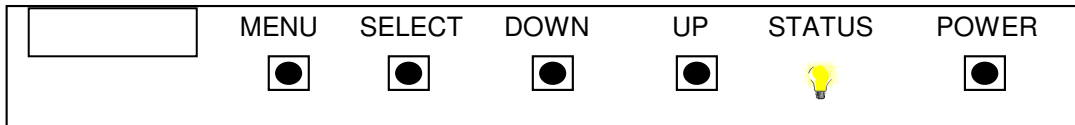

Function of each OSD key

No.	Button	Switch Function
1	Menu	1. Open the OSD Main Menu / Close the OSD Main Menu
2	Select	1. Select a Item
3	Down	1. Move to downside on menu list 2. decrease the value of selected item
4	Up	1. Move to upside on menu list 2. Increase the value of selected item
5	Power	1. Turn on power / Turn off power

◆ Hot-Key : One-click control

- Auto adjust : "down" key
- Source Switch (analog RGB, DVI) : "select" key

◆ Status LED

- Green : Normal State
- Amber flashing : DPMS mode (Can't find signal)

7. OSD (On-Screen-Display)

7.1. Main Menu

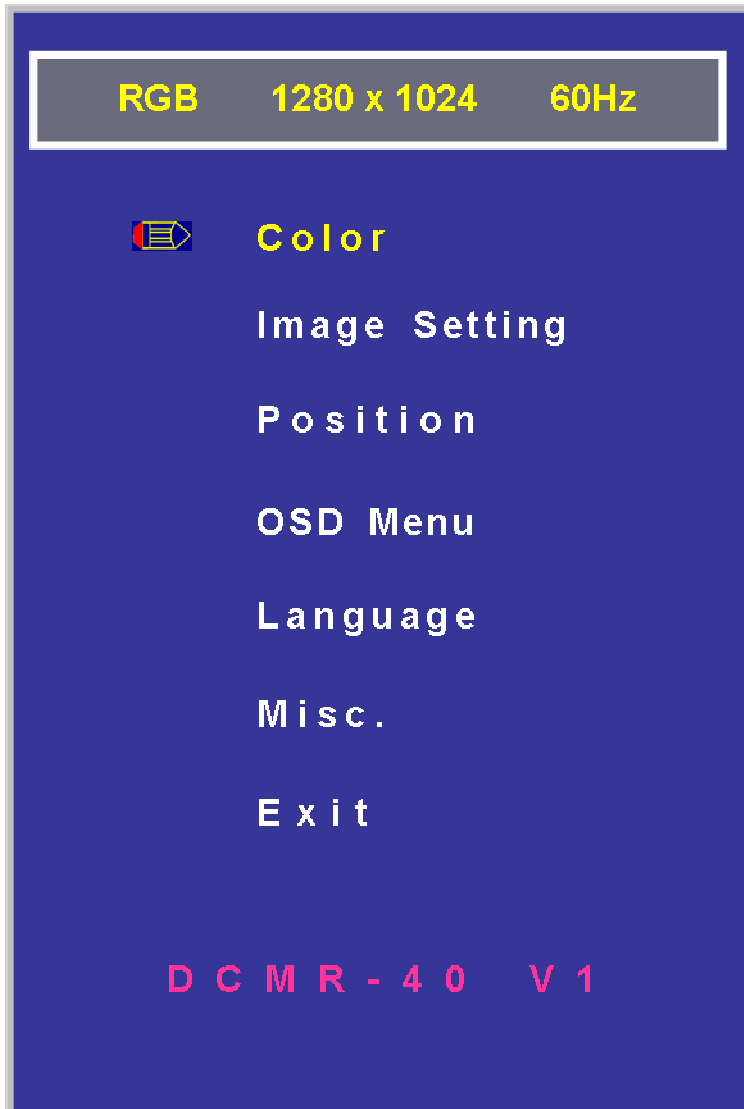

Color :	Adjust and correct the color
Image Setting :	Adjust and correct the image
Position :	Adjust the H-/V- Position of display
OSD Menu :	Adjust the On-Screen-Display
Language :	Select a language of OSD
Misc. :	All other settings
Exit :	Close the main menu

7.2. Sub-Memu : Color

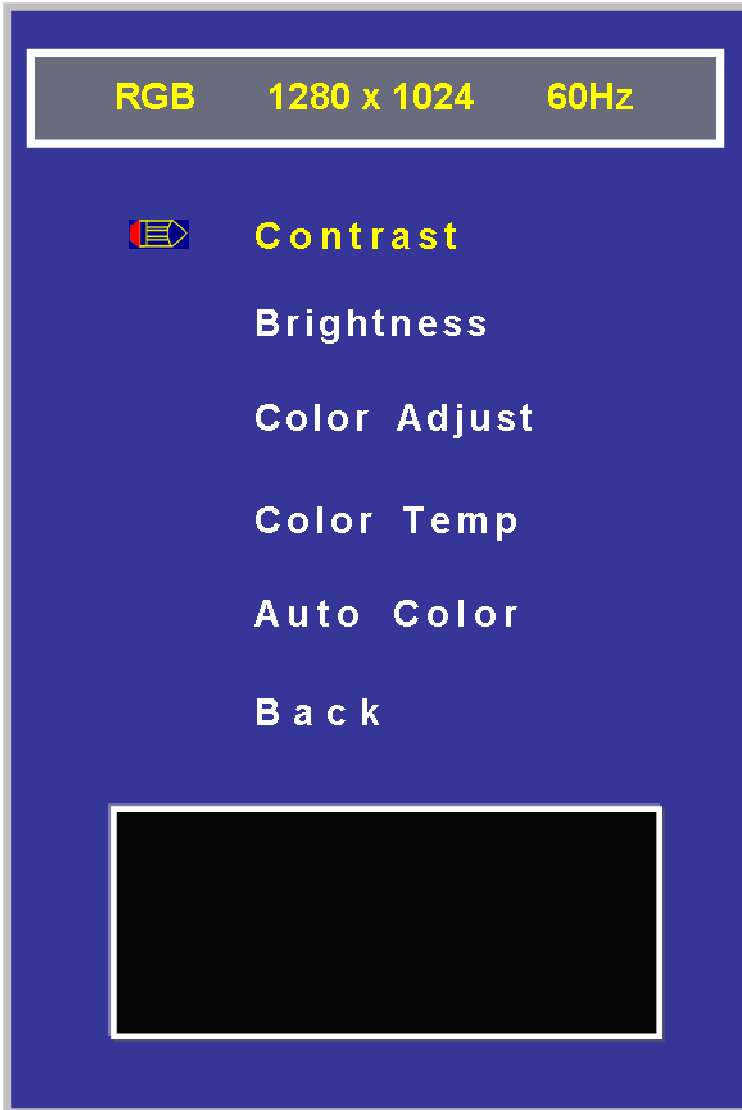

- Contrast : Adjust the contrast of the image
- Brightness : Adjust the brightness of the image
- Color Adjust : Adjust the value of red, green and blue
- Color Temp : Adjust the color temperature
- Auto Color : Run the auto config of the Color
- Back : Back to main menu

7.3. Sub-Memu : Image Setting

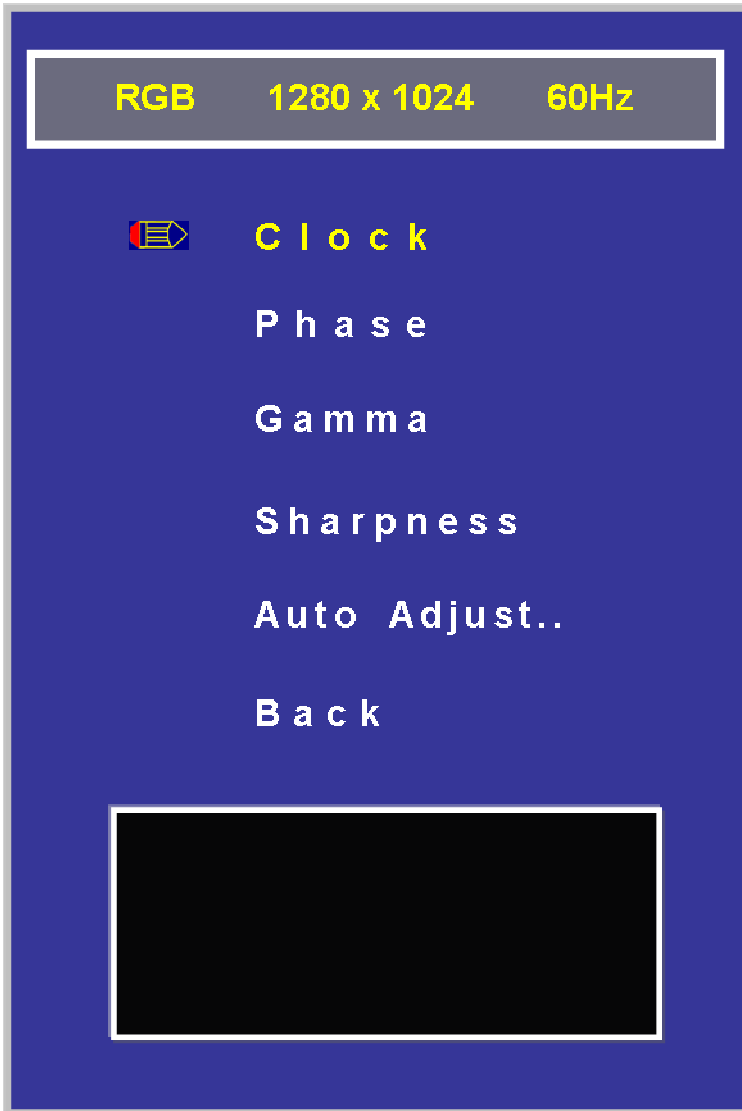

Clock :	Adjust the clock of the image
Phase :	Adjust the phase of the image
Gamma :	Adjust gamma level of the image
Sharpness :	Adjust the sharpness of the image
Auto Adjust :	Run the auto config of the image
Back :	Back to main menu

7.4. Sub-Memu : Position

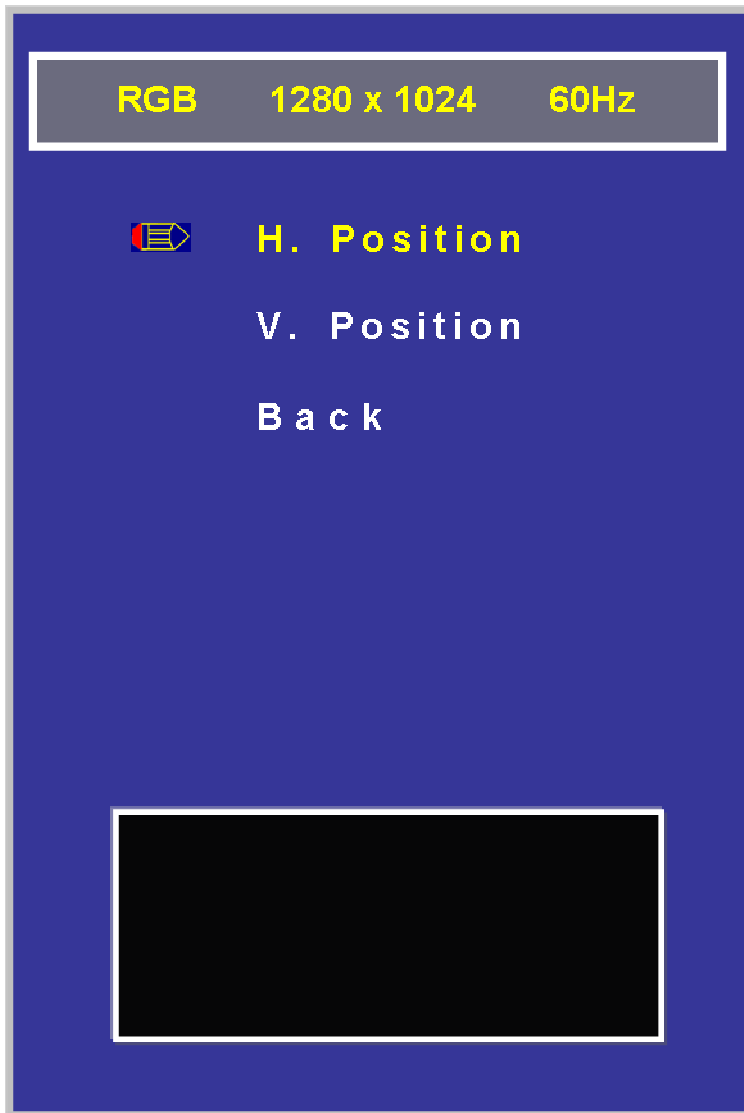

- H. Position : Adjust the H. position of the image
V. Position : Adjust the V. position of the image
Back : Back to main menu

7.5. Sub-Memu : OSD Menu



- OSD H. Pos. : Adjust the H. position of the OSD
- OSD V. Pos. : Adjust the H. position of the OSD
- OSD Timer : Adjust the OSD off timer
- Back : Back to main menu

7.6. Sub-Menu : Language



Korean : Select a Korean
English : Select a English
Deutsch Select a Germany

7.7. Sub-Menu : Misc.



Signal Source : Select the input source

Reset : Factory reset

Back : Back to main menu

8. Input Connectors

8.1. Power Input connector

- Power input connector (P100) : 2.5 Power DC Jack

Pin No.	Symbol	Description
1	GND	GND
2	GND	GND
3	Vin	+12Vdc

- Power input connector (J4) : SMAW200-02 by Yeonho (2mm Pitch / 2 Pin)

Pin No.	Symbol	Description
1	Vin	+12Vdc
2	GND	GND

- Power input connector (J5) : : SMAW250-02 by Yeonh (2.5mm Pitch / 2 Pin)

Pin No.	Symbol	Description
1	Vin	+12Vdc
2	GND	GND

8.2. DVI Input connector, single link

- DVI Input connector (J201) : DVI-D

Pin No.	Symbol	Signal Name	Pin No.	Symbol	Signal Name
1	RX2-	DVI Data 2 -	16	HPD	Hot Plug Detect
2	RX2+	DVI Data 2 +	17	RX0-	DVI Data 0 -
3	GND	2/4 Shield	18	RX0+	DVI Data 0 +
4	NC	DVI Data 4 -	19	GND	0/5 Shield
5	NC	DVI Data 4 +	20	NC	DVI Data 5 -
6	SCL	DDC Data Clock	21	NC	DVI Data 5 +
7	SDA	DDC Data	22	GND	Clock Shield
8	NC	Analog VSYNC	23	RXC+	DVI Clock +
9	RX1-	DVI Data 1 -	24	RXC-	DVI Clock -
10	RX1+	DVI Data 1 +	C1	NC	Analog RED
11	GND	1/3 Shield	C2	NC	Analog Green
12	NC	DVI Data 3 -	C3	NC	Analog Blue
13	NC	DVI Data 3 +	C4	NC	Analog HSYNC
14	DVI +5V	+5V	C5	NC	Analog GND
15	SYNC GND	Check DVI			

- DVI Input connector (J1) : SMW200-15 by Yeonho (2mm Pitch / 15 Pin)

Pin No.	Symbol	Signal Name	Pin No.	Symbol	Signal Name
1	RX2-	DVI Data 2 -	9	GND	Ground
2	RX2+	DVI Data 2 +	10	RXC-	DVI Clock -
3	GND	Ground	11	RXC+	DVI Clock +
4	RX1-	DVI Data 1 -	12	SCL	DDC Data Clock
5	RX1+	DVI Data 1 +	13	SDA	DDC Data
6	GND	Ground	14	DVI +5V	+5V
7	RX0-	DVI Data 0 -	15	DVI +5V	+5V
8	RX0+	DVI Data 0 +			

8.3. Analog RGB Input connector

- RGB Input connector (J200) : D-Sub 15 Pin

Pin No.	Symbol	Signal Name	Pin No.	Symbol	Signal Name
1	Red	R0 +	9	VGA +5V	+5V
2	Green	G0 +	10	Check VGA	Check VGA
3	Blue	B0 +	11	GND	Ground
4	GND	Ground	12	SDA	DDC Data
5	GND	Ground	13	AHS	Analog HSYNC
6	Red	R0 -	14	AVS	Analog VSYNC
7	Green	G0 -	15	SCL	DDC Data Clock
8	Blue	B0 -			

- RGB Input connector (J2) : SMW200-15 by Yeonho (2mm Pitch / 15 Pin)

Pin No.	Symbol	Signal Name	Pin No.	Symbol	Signal Name
1	SCL	DDC Data Clock	9	GND	Ground
2	AVS	Analog VSYNC	10	GND	Ground
3	AHS	Analog HSYNC	11	GND	Ground
4	SDA	DDC Data	12	GND	Ground
5	NC	-	13	Blue	B0 +
6	GND	Ground	14	Green	G0 +
7	NC	-	15	Red	R0 +
8	GND	Ground			

8.4. OSD, LED Interface Connector (J500)

- SMW200-12 by Yeonho (2mm Pitch / 12 Pin)

Pin No.	Symbol	Signal Name	Pin No.	Symbol	Signal Name
1	KEY1	Up KEY	7	VCC	VCC
2	KEY2	Down KEY	8	LED_G	Green LED
3	GND	Ground	9	GND	Ground
4	KEY3	Select KEY	10	KEY5	Power KEY
5	KEY4	Menu KEY	11	KEY6	IR_INT
6	LED_R	Red LED	12	GND	Ground

8.5. External Power Connector (J6)

Connector : 0022057045 made by Molex, matching connector Molex 0050375043

Pin No	Symbol	Description
1	12	DC 12 V
2	5	DC 5 V
3	GND	Ground
4	GND	Ground

8.6. DDC-2 Connector (J3)

Pin No	Symbol	Description
1	GND	Ground
2	SCL	DDC2-SCL
3	SDA	DDC2-SDA
4	5	DC 5 V

9. Output Connectors for LCD Interface

9.1.LVDS Interface (J502)

- 12507WR-30 by Yeonho (1.25mm Pitch / 30 Pin) (HRS DF14H20P1.25H)

Pin No	Description	Pin No.	Description	Pin No.	Description
1	VCC	11	RXOIN1 -	21	RXEIN0 +
2	VCC	12	RXOIN1 +	22	RXEIN1 -
3	VCC	13	RXOIN2 -	23	RXEIN1 +
4	VCC	14	RXOIN2 +	24	RXEIN2 -
5	NC	15	RXOCKIN -	25	RXEIN2 +
6	GND	16	RXOCKIN +	26	RXECKIN -
7	GND	17	RXOIN3 -	27	RXECKIN +
8	GND	18	RXOIN3 +	28	RXEIN3 -
9	RXOIN0 -	19	GND	29	RXEIN3 +
10	RXOIN0 +	20	RXEIN0 -	30	GND

9.2.TTL - Interface (J503)

- 2mm Pitch / Dip 40 Pin

No	Description	No	Description
1	GND	21	B2
2	DCLK	22	B3
3	GND	23	B4
4	DHS	24	B5
5	DVS	25	B6
6	GND	26	B7
7	R2	27	GND
8	R3	28	DEN
9	R4	29	GND
10	R5	30	Vcc
11	R6	31	Vcc
12	R7	32	Vcc
13	GND	33	GND
14	G2	34	(R0)
15	G3	35	(R1)
16	G4	36	(G0)
17	G5	37	(G1)
18	G6	38	(B0)
19	G7	39	(B1)
20	GND	40	GND

9.3. Backlight Power Connector (J501)

- SMW200-07 by Yeonho (2mm Pitch / 7 Pin)

Pin No.	Symbol	Description
1	GND	Ground
2	GND	Ground
3	GND	Ground
4	ADJ	0.0 ~ 5.0 Vdc
5	On / Off	0 / 5 Vdc(High Active)
6	Vin	+12Vdc Input
7	Vin	+12Vdc Input

10. Mechanical Dimension

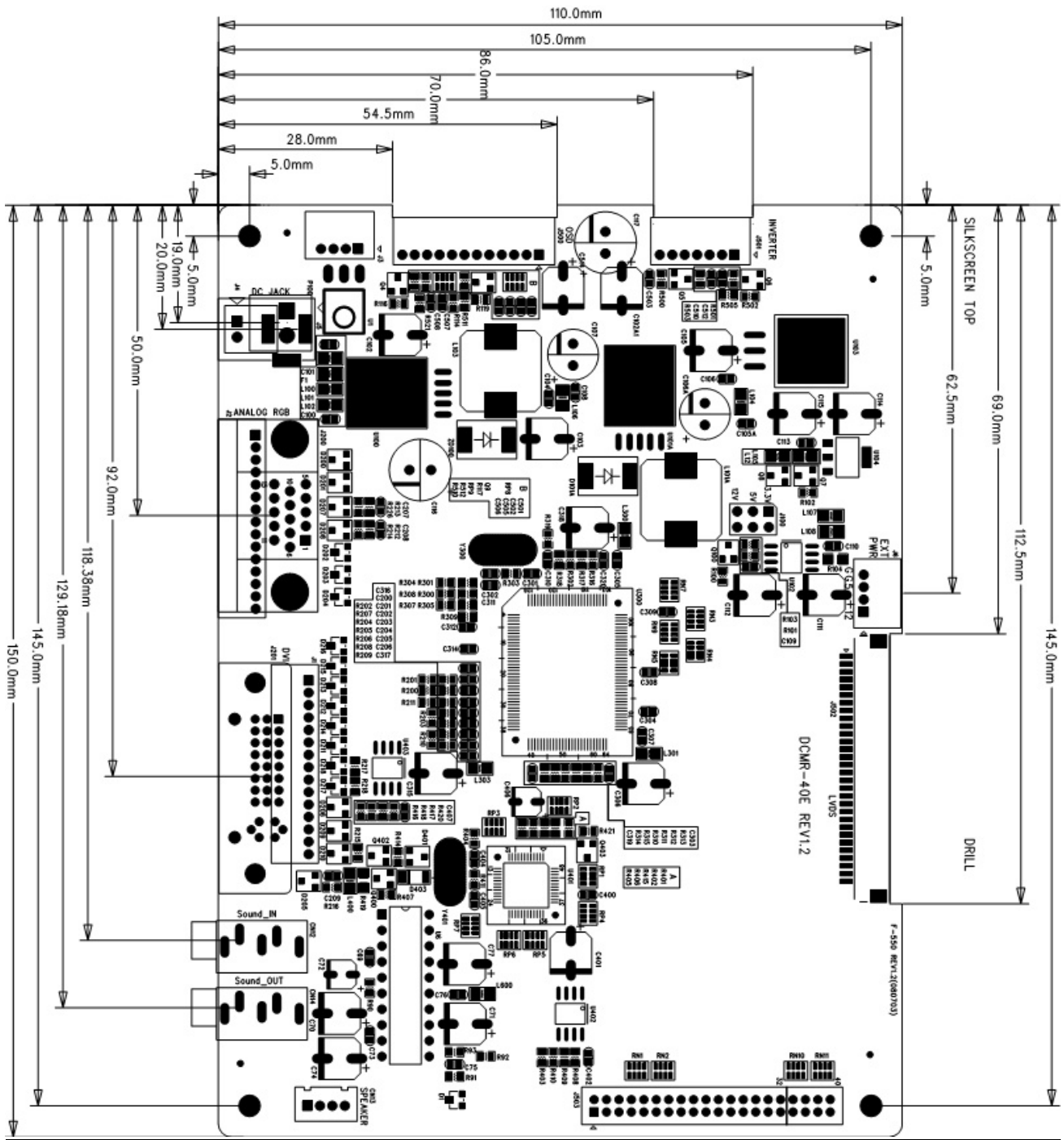

11. Reliability

Test item	Condition
High temperature storage test	+70°
Low temperature storage test	-20°
High temperature operation test	+60°
Low temperature operation test	-10°
Vibration test	
Shock test	
Altitude test	
Humidity test	

12. Absolute maximum ratings

Test item	Condition
High temperature storage	+70°
Low temperature storage	-20°
High temperature operation	+60°
Low temperature operation ²	-10°

13. Mounting rules

- You must mount a module using holes arranged in four corners.
- Avoid any bend force during mounting

14. Operating Precautions

- The spike noise causes the mis-operation of circuits. It should be lower than following voltage : $V = \pm 200\text{mV}$ (Over and under shoot voltage)
- Be careful for condensation at sudden temperature change. Condensation makes damage to electrical contacted parts.
- Module has high frequency circuits. Sufficient suppression to the electromagnetic interference shall be done by system manufacturers. Grounding and shielding methods may be important to minimized the interference

² Phase shift or clock shift can appear between -10°C and 0°C

15. Packing / Labels

16. General Cautions

- Never touch the inverter(dc-ac) while power is connected. Inverter should be properly mounted in the system. All transformers on the inverter should be covered with non-conductive heat-resistant material. Inverter is a source of very high voltages. Precaution must be taken to avoid electrical shocks.
- When preparing a cable for a specific flat panel, always refer to appropriate cable pin-out and flat panel specification. Always check the flat panel signals before connecting the cable. Any incorrect pin connection may damage the flat panel permanently.
- Should you need any technical help, please contact Beck GmbH & Co. Elektronik Bauelemente KG